



# **BIDDING DOCUMENTS**

(As Harmonized with Development Partners)

## **CONSTRUCTION OF LOWLAND VEGETABLE / MUSHROOM PRODUCTION BUILDING**

**PB No. 2024I –32**

**Poblacion Norte, Lidlidda, Ilocos Sur**

**Pre-Bid Conference:**

**July 31, 2024 @ 10:00 am**

**BID SUBMISSION:**

**August 12, 2024 @ 1:30pm**

**BID OPENING:**

**August 12, 2024 @ 2:00 pm**



## TABLE OF CONTENTS

<b>Glossary of Terms, Abbreviations, and Acronyms .....</b>	<b>4</b>
<b>Section I. Invitation to Bid.....</b>	<b>6</b>
<b>Section II. Instructions to Bidders .....</b>	<b>8</b>
1. Scope of Bid.....	8
2. Funding Information .....	8
3. Bidding Requirements.....	8
4. Corrupt, Fraudulent, Collusive, Coercive, and Obstructive Practices .....	8
5. Eligible Bidders.....	8
6. Origin of Associated Goods .....	9
7. Subcontracts .....	9
8. Pre-Bid Conference.....	9
9. Clarification and Amendment of Bidding Documents .....	9
10. Documents Comprising the Bid: Eligibility and Technical Components .....	9
11. Documents Comprising the Bid: Financial Component .....	10
12. Alternative Bids .....	10
13. Bid Prices .....	10
14. Bid and Payment Currencies .....	10
15. Bid Security.....	10
16. Sealing and Marking of Bids.....	11
17. Deadline for Submission of Bids .....	11
18. Opening and Preliminary Examination of Bids .....	11
19. Detailed Evaluation and Comparison of Bids.....	11
20. Post Qualification.....	12
21. Signing of the Contract .....	12
<b>Section III. Bid Data Sheet .....</b>	<b>13</b>
<b>Section IV. General Conditions of Contract .....</b>	<b>14</b>
1. Scope of Contract.....	14
2. Sectional Completion of Works .....	14
3. Possession of Site.....	14
4. The Contractor’s Obligations.....	14
5. Performance Security .....	15



6.	Site Investigation Reports .....	15
7.	Warranty.....	15
8.	Liability of the Contractor.....	15
9.	Termination for Other Causes .....	15
10.	Dayworks .....	15
11.	Program of Work.....	16
12.	Instructions, Inspections and Audits .....	16
13.	Advance Payment.....	16
14.	Progress Payments .....	16
15.	Operating and Maintenance Manuals.....	16
<b>Section V. Special Conditions of Contract .....</b>		<b>17</b>
<b>Section VI. Specifications .....</b>		<b>18</b>
<b>Section VII. Drawings .....</b>		<b>Error! Bookmark not defined.</b>
<b>Section VIII. Bill of Quantities .....</b>		<b>32</b>
<b>Section IX. Checklist of Technical and Financial Documents .....</b>		<b>32</b>

## *Glossary of Terms, Abbreviations, and Acronyms*

**ABC** – Approved Budget for the Contract.

**ARCC** – Allowable Range of Contract Cost.

**BAC** – Bids and Awards Committee.

**Bid** – A signed offer or proposal to undertake a contract submitted by a bidder in response to and in consonance with the requirements of the bidding documents. Also referred to as *Proposal* and *Tender*. (2016 revised IRR, Section 5[c])

**Bidder** – Refers to a contractor, manufacturer, supplier, distributor and/or consultant who submits a bid in response to the requirements of the Bidding Documents. (2016 revised IRR, Section 5[d])

**Bidding Documents** – The documents issued by the Procuring Entity as the bases for bids, furnishing all information necessary for a prospective bidder to prepare a bid for the Goods, Infrastructure Projects, and/or Consulting Services required by the Procuring Entity. (2016 revised IRR, Section 5[e])

**BIR** – Bureau of Internal Revenue.

**BSP** – Bangko Sentral ng Pilipinas.

**CDA** – Cooperative Development Authority.

**Consulting Services** – Refer to services for Infrastructure Projects and other types of projects or activities of the GOP requiring adequate external technical and professional expertise that are beyond the capability and/or capacity of the GOP to undertake such as, but not limited to: (i) advisory and review services; (ii) pre-investment or feasibility studies; (iii) design; (iv) construction supervision; (v) management and related services; and (vi) other technical services or special studies. (2016 revised IRR, Section 5[i])

**Contract** – Refers to the agreement entered into between the Procuring Entity and the Supplier or Manufacturer or Distributor or Service Provider for procurement of Goods and Services; Contractor for Procurement of Infrastructure Projects; or Consultant or Consulting Firm for Procurement of Consulting Services; as the case may be, as recorded in the Contract Form signed by the parties, including all attachments and appendices thereto and all documents incorporated by reference therein.

**Contractor** – is a natural or juridical entity whose proposal was accepted by the Procuring Entity and to whom the Contract to execute the Work was awarded. Contractor as used in these Bidding Documents may likewise refer to a supplier, distributor, manufacturer, or consultant.

**CPI** – Consumer Price Index.

**DOLE** – Department of Labor and Employment.

**DTI** – Department of Trade and Industry.

**Foreign-funded Procurement or Foreign-Assisted Project** – Refers to procurement whose funding source is from a foreign government, foreign or international financing institution as specified in the Treaty or International or Executive Agreement. (2016 revised IRR, Section 5[b]).

**GFI** – Government Financial Institution.

**GOCC** – Government-owned and/or –controlled corporation.

**Goods** – Refer to all items, supplies, materials and general support services, except Consulting Services and Infrastructure Projects, which may be needed in the transaction of public businesses or in the pursuit of any government undertaking, project or activity, whether in the nature of equipment, furniture, stationery, materials for construction, or personal property of any kind, including non-personal or contractual services such as the repair and maintenance of equipment and furniture, as well as trucking, hauling, janitorial, security, and related or analogous services, as well as procurement of materials and supplies provided by the Procuring Entity for such services. The term “related” or “analogous services” shall include, but is not limited to, lease or purchase of office space, media advertisements, health maintenance services, and other services essential to the operation of the Procuring Entity. (2016 revised IRR, Section 5[r])

**GOP** – Government of the Philippines.

**Infrastructure Projects** – Include the construction, improvement, rehabilitation, demolition, repair, restoration or maintenance of roads and bridges, railways, airports, seaports, communication facilities, civil works components of information technology projects, irrigation, flood control and drainage, water supply, sanitation, sewerage and solid waste management systems, shore protection, energy/power and electrification facilities, national buildings, school buildings, hospital buildings, and other related construction projects of the government. Also referred to as *civil works or works*. (2016 revised IRR, Section 5[u])

**LGUs** – Local Government Units.

**NFCC** – Net Financial Contracting Capacity.

**NGA** – National Government Agency.

**PCAB** – Philippine Contractors Accreditation Board.

**PhilGEPS** - Philippine Government Electronic Procurement System.

**Procurement Project** – refers to a specific or identified procurement covering goods, infrastructure project or consulting services. A Procurement Project shall be described, detailed, and scheduled in the Project Procurement Management Plan prepared by the agency which shall be consolidated in the procuring entity's Annual Procurement Plan. (GPPB Circular No. 06-2019 dated 17 July 2019)

**PSA** – Philippine Statistics Authority.

**SEC** – Securities and Exchange Commission.

**SLCC** – Single Largest Completed Contract.

**UN** – United Nations.

*Section I. Invitation to Bid for*

**CONSTRUCTION OF LOWLAND VEGETABLE/ MUSHROOM  
PRODUCTION BUILDING  
PB No. 2024I-33**

1. The Municipal Government of Lidlidda, through the **RA 7171 2021 Share** intends to apply the sum of **Three Million Eight Hundred Twenty Four Thousand Five Hundred Forty Nine Pesos & 95/100 (P 3,824,549.95)** being the Approved Budget for the Contract (ABC) to payments under the contract for the **Construction of Lowland Vegetable / Mushroom Production Building - under PB 2024I-32. Bids received in excess of the ABC shall be automatically rejected at bid opening.**
2. The Municipal Government of Lidlidda now invites bids for the above Procurement Project. Completion of the Works is required within **60 Calendar Days** upon receipt of the **Notice To Proceed**. Bidders should have completed a contract similar to the Project. The description of an eligible bidder is contained in the Bidding Documents, particularly, in Section II (Instructions to Bidders).
3. Bidding will be conducted through open competitive bidding procedures using non-discretionary “*pass/fail*” criterion as specified in the 2016 revised Implementing Rules and Regulations (IRR) of Republic Act (RA) No. 9184.
4. Interested bidders may obtain further information from **WILBERT E. JOSE, BAC CHAIRPERSON** and inspect the Bidding Documents at the address given below from **Monday to Friday @ 8:00am to 5:00pm**.
5. A complete set of Bidding Documents may be acquired by interested bidders on **July 19, 2024 till 12:00 pm of August 12, 2024** from the given address and website/s below and upon payment of the applicable fee for the Bidding Documents, pursuant to the latest Guidelines issued by the GPPB, in the amount of **Five Thousand Pesos (P 5,000.00)**. The Procuring Entity shall allow the bidder to present its proof of payment for the fees **personally, or through messenger, and email**.
6. The Municipal Government of Lidlidda will hold a Pre-Bid Conference<sup>1</sup> on **July 31, 2024 @ 10:00 am**, which shall be open to all interested bidders.
7. Bids must be duly received by the BAC Secretariat through (i) **manual submission at the office address as indicated below on or before 1:30 pm of August 12, 2024. Late bids shall not be accepted.**

---

<sup>1</sup> May be deleted in case the ABC is less than One Million Pesos (PhP1,000,000) where the Procuring Entity may not hold a pre-bid conference.

8. All bids must be accompanied by a bid security in any of the acceptable forms and in the amount stated in **ITB** Clause 16.
9. Bid opening shall be on **August 12, 2024 @ 2:00 pm** at the given address below. Bids will be opened in the presence of the bidders' representatives who choose to attend the activity.
10. The Municipal Government of Lidlidda reserves the right to reject any and all bids, declare a failure of bidding, or not award the contract at any time prior to contract award in accordance with Sections 35.6 and 41 of the 2016 revised Implementing Rules and Regulations (IRR) of RA No. 9184, without thereby incurring any liability to the affected bidder or bidders.
11. For further information, please refer to:

**WILBERT E. JOSE, REA**  
*BAC Chairperson, Municipal Assessor*  
*Municipal Hall, Municipality of Lidlidda, Ilocos Sur*  
*Email add: semelaine77@gmail.com*  
*CP# 09533024088*

12. You may visit the following websites:

For downloading of Bidding Documents: **PHILGEPS PORTAL**, [lidlidda.gov.ph](http://lidlidda.gov.ph),  
**FB Page : LGU LIDLIDDA PROCUREMENT ACTIVITIES**

For online bid submission: *n/a*

July 16, 2024

  
**WILBERT E. JOSE**  
*BAC Chairperson*

## ***Section II. Instructions to Bidders***

### **1. Scope of Bid**

The Procuring Entity, Municipal Government of Lidlidda invites Bids for the ***Construction of Lowland Vegetable/ Mushroom Production Building - PB 2024I-32.***

The Procurement Project (referred to herein as “Project”) is for the construction of Works, as described in Section VI (Specifications).

### **2. Funding Information**

2.1. The GOP through the source of funding as indicated below for **RA 7171 2021 SHARE** in the amount of ***Four Million Pesos (P 4,000,000.00).***

2.2. The source of funding is:

a. LGUs, the Annual or Supplemental Budget, as approved by the Sanggunian.

### **3. Bidding Requirements**

The Bidding for the Project shall be governed by all the provisions of RA No. 9184 and its 2016 revised IRR, including its Generic Procurement Manual and associated policies, rules and regulations as the primary source thereof, while the herein clauses shall serve as the secondary source thereof.

Any amendments made to the IRR and other GPPB issuances shall be applicable only to the ongoing posting, advertisement, or invitation to bid by the BAC through the issuance of a supplemental or bid bulletin.

The Bidder, by the act of submitting its Bid, shall be deemed to have inspected the site, determined the general characteristics of the contracted Works and the conditions for this Project, such as the location and the nature of the work; (b) climatic conditions; (c) transportation facilities; (c) nature and condition of the terrain, geological conditions at the site communication facilities, requirements, location and availability of construction aggregates and other materials, labor, water, electric power and access roads; and (d) other factors that may affect the cost, duration and execution or implementation of the contract, project, or work and examine all instructions, forms, terms, and project requirements in the Bidding Documents.

### **4. Corrupt, Fraudulent, Collusive, Coercive, and Obstructive Practices**

The Procuring Entity, as well as the Bidders and Contractors, shall observe the highest standard of ethics during the procurement and execution of the contract. They or through an agent shall not engage in corrupt, fraudulent, collusive, coercive, and obstructive practices defined under Annex “I” of the 2016 revised IRR of RA No. 9184 or other integrity violations in competing for the Project.

### **5. Eligible Bidders**

5.1. Only Bids of Bidders found to be legally, technically, and financially capable will be evaluated.



- 5.2. The Bidder must have an experience of having completed a Single Largest Completed Contract (SLCC) that is similar to this Project, equivalent to at least fifty percent (50%) of the ABC adjusted, if necessary, by the Bidder to current prices using the PSA's CPI, except under conditions provided for in Section 23.4.2.4 of the 2016 revised IRR of RA No. 9184.

A contract is considered to be "similar" to the contract to be bid if it has the major categories of work stated in the **BDS**.

- 5.3. For Foreign-funded Procurement, the Procuring Entity and the foreign government/foreign or international financing institution may agree on another track record requirement, as specified in the Bidding Document prepared for this purpose.
- 5.4. The Bidders shall comply with the eligibility criteria under Section 23.4.2 of the 2016 IRR of RA No. 9184.

## **6. Origin of Associated Goods**

There is no restriction on the origin of Goods other than those prohibited by a decision of the UN Security Council taken under Chapter VII of the Charter of the UN.

## **7. Subcontracts**

- 7.1. The Bidder may subcontract portions of the Project to the extent allowed by the Procuring Entity as stated herein, but in no case more than fifty percent (50%) of the Project.

The Procuring Entity has prescribed that:

- a. **Subcontracting is not allowed.**

## **8. Pre-Bid Conference**

The Procuring Entity will hold a pre-bid conference for this Project on the specified date and time and either at its physical address at the **Municipal Conference Hall of the Municipal Hall, Lidlidda, Ilocos Sur.**

## **9. Clarification and Amendment of Bidding Documents**

Prospective bidders may request for clarification on and/or interpretation of any part of the Bidding Documents. Such requests must be in writing and received by the Procuring Entity, either at its given address or through electronic mail indicated in the **IB**, at least ten (10) calendar days before the deadline set for the submission and receipt of Bids.

## **10. Documents Comprising the Bid: Eligibility and Technical Components**

- 10.1. The first envelope shall contain the eligibility and technical documents of the Bid as specified in **Section IX. Checklist of Technical and Financial Documents.**
- 10.2. If the eligibility requirements or statements, the bids, and all other documents for submission to the BAC are in foreign language other than English, it must be accompanied by a translation in English, which shall be authenticated by the appropriate Philippine foreign service establishment, post, or the equivalent office having jurisdiction over the foreign bidder's affairs in the Philippines. For Contracting Parties to the Apostille Convention, only the translated documents shall

be authenticated through an apostille pursuant to GPPB Resolution No. 13-2019 dated 23 May 2019. The English translation shall govern, for purposes of interpretation of the bid.

- 10.3. A valid PCAB License is required, and in case of joint ventures, a valid special PCAB License, and registration for the type and cost of the contract for this Project. Any additional type of Contractor license or permit shall be indicated in the **BDS**.
- 10.4. A List of Contractor's key personnel (e.g., Project Manager, Project Engineers, Materials Engineers, and Foremen) assigned to the contract to be bid, with their complete qualification and experience data shall be provided. These key personnel must meet the required minimum years of experience set in the **BDS**.
- 10.5. A List of Contractor's major equipment units, which are owned, leased, and/or under purchase agreements, supported by proof of ownership, certification of availability of equipment from the equipment lessor/vendor for the duration of the project, as the case may be, must meet the minimum requirements for the contract set in the **BDS**.

## **11. Documents Comprising the Bid: Financial Component**

- 11.1. The second bid envelope shall contain the financial documents for the Bid as specified in **Section IX. Checklist of Technical and Financial Documents**.
- 11.2. Any bid exceeding the ABC indicated in paragraph 1 of the **IB** shall not be accepted.
- 11.3. For Foreign-funded procurement, a ceiling may be applied to bid prices provided the conditions are met under Section 31.2 of the 2016 revised IRR of RA No. 9184.

## **12. Alternative Bids**

Bidders shall submit offers that comply with the requirements of the Bidding Documents, including the basic technical design as indicated in the drawings and specifications. Unless there is a value engineering clause in the **BDS**, alternative Bids shall not be accepted.

## **13. Bid Prices**

All bid prices for the given scope of work in the Project as awarded shall be considered as fixed prices, and therefore not subject to price escalation during contract implementation, except under extraordinary circumstances as determined by the NEDA and approved by the GPPB pursuant to the revised Guidelines for Contract Price Escalation guidelines.

## **14. Bid and Payment Currencies**

- 14.1. Bid prices may be quoted in the local currency or tradable currency accepted by the BSP at the discretion of the Bidder. However, for purposes of bid evaluation, Bids denominated in foreign currencies shall be converted to Philippine currency based on the exchange rate as published in the BSP reference rate bulletin on the day of the bid opening.
- 14.2. Payment of the contract price shall be made in:

- a. Philippine Pesos.

## **15. Bid Security**

15.1. The Bidder shall submit a Bid Securing Declaration or any form of Bid Security in the amount indicated in the **BDS**, which shall be not less than the percentage of the ABC in accordance with the schedule in the **BDS**.

15.2. The Bid and bid security shall be valid within 30 days. Any bid not accompanied by an acceptable bid security shall be rejected by the Procuring Entity as non-responsive.

#### **16. Sealing and Marking of Bids**

Each Bidder shall submit one copy of the first and second components of its Bid.

The Procuring Entity may request additional hard copies and/or electronic copies of the Bid. However, failure of the Bidders to comply with the said request shall not be a ground for disqualification.

If the Procuring Entity allows the submission of bids through online submission to the given website or any other electronic means, the Bidder shall submit an electronic copy of its Bid, which must be digitally signed. An electronic copy that cannot be opened or is corrupted shall be considered non-responsive and, thus, automatically disqualified.

#### **17. Deadline for Submission of Bids**

The Bidders shall submit on the specified date and time and either at its physical address or through online submission as indicated in paragraph 7 of the **IB**.

#### **18. Opening and Preliminary Examination of Bids**

18.1. The BAC shall open the Bids in public at the time, on the date, and at the place specified in paragraph 9 of the **IB**. The Bidders' representatives who are present shall sign a register evidencing their attendance. In case videoconferencing, webcasting or other similar technologies will be used, attendance of participants shall likewise be recorded by the BAC Secretariat.

In case the Bids cannot be opened as scheduled due to justifiable reasons, the rescheduling requirements under Section 29 of the 2016 revised IRR of RA No. 9184 shall prevail.

18.2. The preliminary examination of Bids shall be governed by Section 30 of the 2016 revised IRR of RA No. 9184.

#### **19. Detailed Evaluation and Comparison of Bids**

19.1. The Procuring Entity's BAC shall immediately conduct a detailed evaluation of all Bids rated "*passed*" using non-discretionary pass/fail criteria. The BAC shall consider the conditions in the evaluation of Bids under Section 32.2 of 2016 revised IRR of RA No. 9184.

19.2. If the Project allows partial bids, all Bids and combinations of Bids as indicated in the **BDS** shall be received by the same deadline and opened and evaluated simultaneously so as to determine the Bid or combination of Bids offering the lowest calculated cost to the Procuring Entity. Bid Security as required by **ITB** Clause 16 shall be submitted for each contract (lot) separately.



19.3. In all cases, the NFCC computation pursuant to Section 23.4.2.6 of the 2016 revised IRR of RA No. 9184 must be sufficient for the total of the ABCs for all the lots participated in by the prospective Bidder.

**20. Post Qualification**

Within a non-extendible period of five (5) calendar days from receipt by the Bidder of the notice from the BAC that it submitted the Lowest Calculated Bid, the Bidder shall submit its latest income and business tax returns filed and paid through the BIR Electronic Filing and Payment System (eFPS), and other appropriate licenses and permits required by law and stated in the **BDS**.

**21. Signing of the Contract**

The documents required in Section 37.2 of the 2016 revised IRR of RA No. 9184 shall form part of the Contract. Additional Contract documents are indicated in the **BDS**.

## Section III. Bid Data Sheet

### Bid Data Sheet

<b>ITB Clause</b>																																		
5.2	For this purpose, contracts similar to the Project refer to contracts which have the same major categories of work, which shall be: <b>BUILDINGS</b>																																	
7.1	N/A																																	
10.3	N/A																																	
10.4	The key personnel must meet the required minimum years of experience set below:																																	
	<table style="width: 100%; border-collapse: collapse;"> <thead> <tr> <th style="text-align: left;"><u>Key Personnel</u></th> <th style="text-align: left;"><u>General Experience</u></th> <th style="text-align: left;"><u>Relevant Experience</u></th> </tr> </thead> <tbody> <tr> <td><b>CONSTRUCTION FOREMAN</b></td> <td><u>1 year</u></td> <td><b>GENERAL</b></td> </tr> <tr> <td>Skilled and unskilled Laborers</td> <td></td> <td></td> </tr> <tr> <td>First Aider</td> <td></td> <td></td> </tr> <tr> <td>Part time safety practitioner</td> <td></td> <td></td> </tr> </tbody> </table>	<u>Key Personnel</u>	<u>General Experience</u>	<u>Relevant Experience</u>	<b>CONSTRUCTION FOREMAN</b>	<u>1 year</u>	<b>GENERAL</b>	Skilled and unskilled Laborers			First Aider			Part time safety practitioner																				
<u>Key Personnel</u>	<u>General Experience</u>	<u>Relevant Experience</u>																																
<b>CONSTRUCTION FOREMAN</b>	<u>1 year</u>	<b>GENERAL</b>																																
Skilled and unskilled Laborers																																		
First Aider																																		
Part time safety practitioner																																		
10.5	The minimum major equipment requirements are the following:																																	
	<table style="width: 100%; border-collapse: collapse;"> <thead> <tr> <th style="text-align: left;"><u>Equipment</u></th> <th style="text-align: left;"><u>Capacity</u></th> <th style="text-align: left;"><u>Number of Units</u></th> </tr> </thead> <tbody> <tr> <td>Backhoe</td> <td>(0.80 cu.m)</td> <td style="text-align: center;">1</td> </tr> <tr> <td>Water Truck/Pump</td> <td style="text-align: center;">16000</td> <td style="text-align: center;">2</td> </tr> <tr> <td>Concrete Vibrator</td> <td></td> <td style="text-align: center;">2</td> </tr> <tr> <td>Bar Cutter</td> <td></td> <td style="text-align: center;">1</td> </tr> <tr> <td>One Bagger Mixer</td> <td></td> <td style="text-align: center;">1</td> </tr> <tr> <td>Transit Mixer</td> <td style="text-align: center;">5 cum</td> <td style="text-align: center;">1</td> </tr> <tr> <td>Vibratory Roller</td> <td></td> <td style="text-align: center;">1</td> </tr> <tr> <td>Concrete Screeder</td> <td></td> <td style="text-align: center;">1</td> </tr> <tr> <td>Concrete Saw</td> <td style="text-align: center;">14" dia blade</td> <td style="text-align: center;">1</td> </tr> <tr> <td>Welding Machine</td> <td></td> <td style="text-align: center;">1</td> </tr> </tbody> </table>	<u>Equipment</u>	<u>Capacity</u>	<u>Number of Units</u>	Backhoe	(0.80 cu.m)	1	Water Truck/Pump	16000	2	Concrete Vibrator		2	Bar Cutter		1	One Bagger Mixer		1	Transit Mixer	5 cum	1	Vibratory Roller		1	Concrete Screeder		1	Concrete Saw	14" dia blade	1	Welding Machine		1
<u>Equipment</u>	<u>Capacity</u>	<u>Number of Units</u>																																
Backhoe	(0.80 cu.m)	1																																
Water Truck/Pump	16000	2																																
Concrete Vibrator		2																																
Bar Cutter		1																																
One Bagger Mixer		1																																
Transit Mixer	5 cum	1																																
Vibratory Roller		1																																
Concrete Screeder		1																																
Concrete Saw	14" dia blade	1																																
Welding Machine		1																																
	Value Engineering. The bidder may, at any time, submit to the Engineer a written proposal which will, if adopted, (i) accelerate completion, (ii) reduce the cost to the procuring entity of executing, maintaining or operating the works, (iii) improve the efficiency or value to the procuring entity of the completed works, or (iv) otherwise be of benefit to the government. The proposal shall be prepared at the cost of the Bidder/Contractor.																																	
15.1	The bid security shall be in the form of a Bid Securing Declaration or any of the following forms and amounts: <ul style="list-style-type: none"> <li>a. The amount of not less than <b>Seventy Six Thousand Four Hundred Ninety One Pesos (P 76,491.00)</b> , 2% of ABC, if bid security is in cash, cashier's/manager's check, bank draft/guarantee or irrevocable letter of credit;</li> <li>b. The amount of not less than <b>One Hundred Ninety One Thousand Two Hundred Twenty Seven Pesos &amp; 50/100 (P 191,227.50)</b>, (5%) of ABC if bid security is in Surety Bond.</li> </ul>																																	
19.2	Partial bids are not allowed.																																	
20	N/A																																	

21	<i>Additional contract documents relevant to the Project that may be required by existing laws and/or the Procuring Entity, such as <u>construction schedule and S-curve, manpower schedule, construction methods, equipment utilization schedule, construction safety and health program approved by the DOLE, and other acceptable tools of project scheduling.</u></i>
----	---

## *Section IV. General Conditions of Contract*

**1. Scope of Contract**

This Contract shall include all such items, although not specifically mentioned, that can be reasonably inferred as being required for its completion as if such items were expressly mentioned herein. All the provisions of RA No. 9184 and its 2016 revised IRR, including the Generic Procurement Manual, and associated issuances, constitute the primary source for the terms and conditions of the Contract, and thus, applicable in contract implementation. Herein clauses shall serve as the secondary source for the terms and conditions of the Contract.

This is without prejudice to Sections 74.1 and 74.2 of the 2016 revised IRR of RA No. 9184 allowing the GPPB to amend the IRR, which shall be applied to all procurement activities, the advertisement, posting, or invitation of which were issued after the effectivity of the said amendment.

**2. Sectional Completion of Works**

If sectional completion is specified in the **Special Conditions of Contract (SCC)**, references in the Conditions of Contract to the Works, the Completion Date, and the Intended Completion Date shall apply to any Section of the Works (other than references to the Completion Date and Intended Completion Date for the whole of the Works).

**3. Possession of Site**

4.1. The Procuring Entity shall give possession of all or parts of the Site to the Contractor based on the schedule of delivery indicated in the **SCC**, which corresponds to the execution of the Works. If the Contractor suffers delay or incurs cost from failure on the part of the Procuring Entity to give possession in accordance with the terms of this clause, the Procuring Entity’s Representative shall give the Contractor a Contract Time Extension and certify such sum as fair to cover the cost incurred, which sum shall be paid by Procuring Entity.

4.2. If possession of a portion is not given by the above date, the Procuring Entity will be deemed to have delayed the start of the relevant activities. The resulting adjustments in contract time to address such delay may be addressed through contract extension provided under Annex “E” of the 2016 revised IRR of RA No. 9184.

**4. The Contractor’s Obligations**

The Contractor shall employ the key personnel named in the Schedule of Key Personnel indicating their designation, in accordance with **ITB** Clause 10.3 and specified in the **BDS**, to carry out the supervision of the Works.

The Procuring Entity will approve any proposed replacement of key personnel only if their relevant qualifications and abilities are equal to or better than those of the personnel listed in the Schedule.

## **5. Performance Security**

- 5.1. Within ten (10) calendar days from receipt of the Notice of Award from the Procuring Entity but in no case later than the signing of the contract by both parties, the successful Bidder shall furnish the performance security in any of the forms prescribed in Section 39 of the 2016 revised IRR.
- 5.2. The Contractor, by entering into the Contract with the Procuring Entity, acknowledges the right of the Procuring Entity to institute action pursuant to RA No. 3688 against any subcontractor be they an individual, firm, partnership, corporation, or association supplying the Contractor with labor, materials and/or equipment for the performance of this Contract.

## **6. Site Investigation Reports**

The Contractor, in preparing the Bid, shall rely on any Site Investigation Reports referred to in the SCC supplemented by any information obtained by the Contractor.

## **7. Warranty**

- 7.1. In case the Contractor fails to undertake the repair works under Section 62.2.2 of the 2016 revised IRR, the Procuring Entity shall forfeit its performance security, subject its property(ies) to attachment or garnishment proceedings, and perpetually disqualify it from participating in any public bidding. All payables of the GOP in his favor shall be offset to recover the costs.
- 7.2. The warranty against Structural Defects/Failures, except that occasioned-on force majeure, shall cover the period from the date of issuance of the Certificate of Final Acceptance by the Procuring Entity. Specific duration of the warranty is found in the SCC.

## **8. Liability of the Contractor**

Subject to additional provisions, if any, set forth in the SCC, the Contractor's liability under this Contract shall be as provided by the laws of the Republic of the Philippines.

If the Contractor is a joint venture, all partners to the joint venture shall be jointly and severally liable to the Procuring Entity.

## **9. Termination for Other Causes**

Contract termination shall be initiated in case it is determined *prima facie* by the Procuring Entity that the Contractor has engaged, before, or during the implementation of the contract, in unlawful deeds and behaviors relative to contract acquisition and implementation, such as, but not limited to corrupt, fraudulent, collusive, coercive, and obstructive practices as stated in ITB Clause 4.

## **10. Dayworks**

Subject to the guidelines on Variation Order in Annex "E" of the 2016 revised IRR of RA No. 9184, and if applicable as indicated in the SCC, the Dayworks rates in the Contractor's Bid

shall be used for small additional amounts of work only when the Procuring Entity's Representative has given written instructions in advance for additional work to be paid for in that way.

## **11. Program of Work**

11.1. The Contractor shall submit to the Procuring Entity's Representative for approval the said Program of Work showing the general methods, arrangements, order, and timing for all the activities in the Works. The submissions of the Program of Work are indicated in the SCC.

11.2. The Contractor shall submit to the Procuring Entity's Representative for approval an updated Program of Work at intervals no longer than the period stated in the SCC. If the Contractor does not submit an updated Program of Work within this period, the Procuring Entity's Representative may withhold the amount stated in the SCC from the next payment certificate and continue to withhold this amount until the next payment after the date on which the overdue Program of Work has been submitted.

## **12. Instructions, Inspections and Audits**

The Contractor shall permit the GOP or the Procuring Entity to inspect the Contractor's accounts and records relating to the performance of the Contractor and to have them audited by auditors of the GOP or the Procuring Entity, as may be required.

## **13. Advance Payment**

The Procuring Entity shall, upon a written request of the Contractor which shall be submitted as a Contract document, make an advance payment to the Contractor in an amount not exceeding fifteen percent (15%) of the total contract price, to be made in lump sum, or at the most two installments according to a schedule specified in the SCC, subject to the requirements in Annex "E" of the 2016 revised IRR of RA No. 9184.

## **14. Progress Payments**

The Contractor may submit a request for payment for Work accomplished. Such requests for payment shall be verified and certified by the Procuring Entity's Representative/Project Engineer. Except as otherwise stipulated in the SCC, materials and equipment delivered on the site but not completely put in place shall not be included for payment.

## **15. Operating and Maintenance Manuals**

15.1. If required, the Contractor will provide "as built" Drawings and/or operating and maintenance manuals as specified in the SCC.

15.2. If the Contractor does not provide the Drawings and/or manuals by the dates stated above, or they do not receive the Procuring Entity's Representative's approval, the Procuring Entity's Representative may withhold the amount stated in the SCC from payments due to the Contractor.



## Section V. Special Conditions of Contract

### Special Conditions of Contract

GCC Clause	
2	N/A
4.1	<i>Schedule of delivery of the possession of the site to the Contractor, whether full or in part - <b>upon receipt of NTP.</b></i>
6	The site investigation reports are: 1. Needs reinforced concrete works 2. Drainage and slope Protection using stone masonry & structural concrete & RSB 3. Needs Aggregate subbase course and surface course 4. Finishing works need railing, roofing works, ceiling works, 125mm CHB with reinforcement, plastering, painting, electrical & aluminum doors, and windows
7.2	<i>Semi-Permanent Structures : Five (5) Years</i>
10	a. No dayworks are applicable to the contract.
11.1	The Contractor shall submit the Program of Work to the Procuring Entity's Representative within <u>3 days</u> of delivery of the Notice of Award.
11.2	The amount to be withheld for late submission of an updated Program of Work is <u>2%</u> of the ABC.
13	The amount of the advance payment is <b><u>15% of the total contract price and schedule of payment.</u></b>
14	Materials and equipment delivered on the site but not completely put in place shall be included for payment.
15.1	The date by which operating and maintenance manuals are required is <b><u>upon completion.</u></b> The date by which "as built" drawings are required is <b><u>upon completion.</u></b>
15.2	The amount to be withheld for failing to produce "as built" drawings and/or operating and maintenance manuals by the date required is 2% of the Contract Price.

# Section VI. Specifications



NAME OF PROJECT : CONSTRUCTION OF LOWLAND VEGETABLE/ MUSHROOM PRODUCTION BUILDING  
 LOCATION : POB. NORTE, LIDLIDDA, ILOCOS SUR

## BACKUP COMPUTATION

PART B. OTHER GENERAL REQUIREMENTS							1.00	cu.m
B.6 Project Billboard / Signboard								
QTY :	1.00	each						
B.7 Occupational Safety and Health Program								1.00
QTY :	1.00	ms.						
PART C. REINFORCED CONCRETE WORKS							30.10	cu.m
405 Structural Concrete Class A (Minor Structures)								
CANAL								
1	W	H	Qty	Vol				
22.80	x	1.10	x	0.13	x	1.00	=	5.13
SLAB								
1	W	H	Qty	Vol				
0.00	x	5.00	x	0.11	x	3.00	=	3.75
FOOTING								
Fence								
1	W	H	Qty	Vol				
1.00	x	3.00	x	0.30	x	18.00	=	5.40
Mushroom Growing House								
1	W	H	Qty	Vol				
1.00	x	1	x	0.300	x	0.20	=	2.40
Slope Protection								
1	W	H	Qty	Vol				
1.00	x	1.00	x	0.30	x	4.50	=	1.35
							9.00	cu.m
COLUMN								
Fence								
1	W	H	Qty	Vol				
0.25	x	0.25	x	3.2	x	18	=	2.90
Mushroom House								
1	W	H	Qty	Vol				
0.25	x	0.25	x	8	x	3	=	0.64
0.25	x	0.25	x	4.5	x	2	=	0.56
0.25	x	0.25	x	4	x	3	=	0.75
Slope Protection								
1	W	H	Qty	Vol				
0.25	x	0.25	x	3.2	x	4	=	1.28
							6.93	cu.m
BEAM								
Fence								
1	W	H	Qty	Vol				
42.22	x	0.20	x	0.25	x	1	=	2.11
Mushroom Growing House								
1	W	H	Qty	Vol				
58	x	0.30	x	0.25	x	1	=	2.70
Slope Protection								
1	W	H	Qty	Vol				
8	x	0.20	x	0.3	x	1	=	0.68
							5.28	cu.m
<b>TOTAL VOLUME</b>							<b>30.10</b>	<b>cu.m</b>
406 Reinforcing Steel Bar, Grade 40 (Minor Structures)							2,388.31	kg
FOOTING								
Fence								
Size	L	Qty	# of Footing	kg/m				
12mm	x	1.00	x	10.00	x	18.00	=	180.2
Mushroom Growing House								
Size	L	Qty	# of Footing	kg/m				
12mm	x	1.00	x	3.00	x	3.00	=	71.2
COLUMN								
Fence								
Size	L	Qty	# of Column	kg/m				
12mm	x	3.20	x	0.30	x	18.00	=	207.584
10mm	x	0.60	x	26.00	x	18.00	=	231.228
Mushroom House								
Size	L	Qty	# of Column	kg/m				
12mm	x	5.30	x	8.00	x	3.00	=	213.228
12mm	x	4.80	x	8.00	x	2.00	=	68.352
12mm	x	4.30	x	0.01	x	3.00	=	31.942
10mm	x	0.8	x	51	x	8	=	202.368
BEAM								
Fence								
Size	L	Qty	# of Beam	kg/m				
12mm	x	2.60	x	4.00	x	12.00	=	118.016
12mm	x	3.60	x	4.00	x	1.00	=	13.528
12mm	x	3.50	x	4.00	x	2.00	=	23.496
10mm	x	0.7	x	28	x	15	=	182.28
Mushroom Growing House								
Size	L	Qty	# of Beam	kg/m				
12mm	x	2.60	x	4.00	x	8.00	=	113.208
12mm	x	2.13	x	8.00	x	8.00	=	92.848
12mm	x	4.60	x	5.00	x	1.00	=	24.564
12mm	x	0.8	x	21	x	18	=	174.552

SLAB	Qty	Unit	Rate	Amount
12mm	1	m <sup>2</sup>	11.52	11.52
12mm	0	m <sup>2</sup>	0	0
<b>Slope Protection</b>				
Slab	1	Qty	168.22	168.22
12mm	0	m <sup>2</sup>	0	0
12mm	0	m <sup>2</sup>	0	0
<b>TOTAL</b>				<b>2,309.21</b>

STATION	DWT	ITEM 125(1)A			ITEM 200			ITEM 210(1)A			
		LENGTH			AREA			LENGTH			
		L/S	R/S	AREA	L/S	R/S	VOLUME	L/S	R/S	AREA	
000+000				7.00		0.00			7.00		
000+005	4.25	14.75	7.00	87.48	1.171	8.700	8.748	11.71	7.00	87.48	
000+010	5.50	7.75	7.00	10.08	0.771	0.700	1.000	7.71	7.00	10.08	
000+015	4.00	11.75	7.00	100.28	1.171	0.700	10.048	4.00	8.71	78.84	
000+020	7.25	11.75	7.00	117.21	1.171	2.700	11.771	11.71	7.00	111.51	
000+025	2.40	11.75		17.87	1.171		1.787	11.71		17.87	
000+030	22.75			8.20		0.070	23.151		8.80	22.81	
000+035	6.20			4.90		0.280	4.781		4.80	40.61	
<b>TOTAL</b>	<b>61.42</b>			<b>407.83</b>			<b>63.783</b>			<b>891.67</b>	

**PART D. SUBBASE AND BASE COURSE** 62.78 sq.m

300 Aggregate Sub-base Course

**PART E. SURFACE COURSE** 691.07 sq.m

311(1)A-2 Portland Cement Concrete Pavement (Unreinforced), 200mm thick

**PART F. DRAINAGE AND SLOPE PROTECTION STRUCTURE** 128.24 sq.m

306 Stone Masonry

STATION	DISTANCE	ITEM 306		
		L/S	R/S	VOLUME
000+000				0.00
000+005	4.25			18.40
000+010	6.75			10.56
000+015	11.00			35.36
<b>TOTAL</b>	<b>34.47</b>			<b>128.24</b>

SM1	SM2	SM3
w1 = 1.20 m	w1 = 1.00 m	w1 = 1.00 m
w2 = 0.60 m	w2 = 0.60 m	w2 = 0.60 m
H1 = 1.00 m	H1 = 2.00 m	H1 = 2.00 m
H2 = 0.60 m	H2 = 1.00 m	H2 = 1.40 m
		Area 5.54 sq.m

AREA SM1	$\frac{1.20 \times 0.60}{2} = 0.36$ sq.m	$\frac{1.00 \times 1.00}{2} = 0.50$ sq.m	$\frac{1.00 \times 1.40}{2} = 0.70$ sq.m
AREA SM2	$\frac{1.00 \times 0.60}{2} = 0.30$ sq.m	$\frac{2.00 \times 1.00}{2} = 1.00$ sq.m	$\frac{1.00 \times 1.40}{2} = 0.70$ sq.m
AREA SM3	$\frac{1.00 \times 0.60}{2} = 0.30$ sq.m	$\frac{1.40 \times 1.00}{2} = 0.70$ sq.m	$\frac{1.00 \times 1.40}{2} = 0.70$ sq.m

**PART G. FINISHING** 30.00 sq.m

1003(1) 4.5mm Fiber Cement Board on Metal Frame Ceiling 30.00 sq.m

l (m.)	w (m.)	Qty (No)	Area (sq.m.)
6.00	5.00	1.00	30.00
Area =			30.00 sq.m

1003(1)H Prepainted metal Panel(Spanned) 26.00 sq.m

l (m.)	w (m.)	Qty (No)	Area (sq.m.)
26.00	1.00	1.00	26.00
Area =			26.00 sq.m

1008 Aluminum Glass Window(s) (sliding/awning/fix) 2.88 sq.m

W1

no of win	l (m.)	w (m.)	Area (sq.m.)
2	1.20	1.20	2.88
Area =			2.88 sq.m
total area =			2.88 sq.m

1010(2) Wooden Panel Door 2.00 sq.m

50(1) Fabricated Metal Roofing Accessory (Flashing/Gutter) 30.00 sq.m

Flashing/gutter

l = 30.00 m

1014 Prepainted Metal Sheets (Rib Type) 56.00 sq.m

l (m.)	w (m.)	Qty (No)	Area (sq.m.)
8	7	1	56.00
Area =			56.00 sq.m

1027(c)	Cement Plaster Finish	area	sq. m.
			268.42
			sq. m.
			268.42
			sq. m.

1032(a)	Painting Works (Masonry Painting)	area	sq. m.
			268.42
			sq. m.
			268.42
			sq. m.

1046	125mm CRB Van Load Bearing (Including Reinforcing Steel)	area	sq. m.
			94.42
			sq. m.
			94.42
			sq. m.

1047(a)	Structural Steel Trusses	PROJ 3	184.07
			kg
			184.07
			kg

- 1108(b) Conduit Works, Boxes and Fittings 2.00 Ls.
- 1109(a) Wires and Wiring Devices 2.00 Ls.
- 1109 Panel Board 2.00 Ls.
- 1109 Lighting Fixtures 2.00 Ls.

1032(a)	Painting Works (Metal Painting)	area	sq. m.
			226.42
			sq. m.

1091(a)	Roofing	area	sq. m.
			133.29
			sq. m.
			133.29
			sq. m.

- 1200 Airconditioning System 2.00 Ls.
- SPL-1 Transformer 2.00 Ls.
- SPL-2 Shelving Cabinet 2.00 Ls.

  
 ENGR. ETRA JEFF C. CABANDAY
   
 Engineer

CHECKED BY:
   
 ENGR. JULIOS ALBERT E. AROLA
   
 Municipal Engineer

APPROVED BY:
   
 ATTY. SHERWIN P. TOMAS
   
 Municipal Mayor

## Section VII. Drawings

 BAYAN NG LIDLIDDA ILOCOS SUR MAAGAP NA PUNANAS MAGPAPALAKAS KALIBTAK LIDLIDDA MAGPAPALAKAS MAGPAPALAKAS MAGPAPALAKAS	<p>Republic of the Philippines The Heritage Province of Ilocos Sur <b>MUNICIPALITY OF LIDLIDDA</b> <i>Poblacion Norte, Lidlidda, Ilocos Sur, 2723, Philippines</i> Email: <a href="mailto:bhslidlidda@gmail.com">bhslidlidda@gmail.com</a> Website: <a href="http://idlidda.gov.ph">idlidda.gov.ph</a> Contact #: 09285181362</p>
<h1>CONSTRUCTION PLAN</h1>	
NAME OF PROJECT : CONSTRUCTION OF LOWLAND VEGETABLE/MUSHROOM PRODUCTION BUILDING	
LOCATION : POB. NORTE, LIDLIDDA, ILOCOS SUR	
PREPARED BY:  ERA JEFF G. MAMUNDA ENGINEERING CLERK	CHECKED BY:  JULIE MARIE E. ARGULA MUNICIPAL ENGINEER
APPROVED BY:  ATTY. SHERMAN P. TOMAS MUNICIPAL MAYOR	



**STA. 0+007.05 - 0+013.05**

**STA. 0+013.05 - 0+020.41**

**STA. 0+029.45 - 0+032.41**

**STA. 0+000 - (-0+01)**

200 mm THK. NOCP  
100 mm THK. Basecourse  
5.00  
1.71  
7.00  
3.60  
1.00  
200 mm THK. FCCP  
100 mm THK. Basecourse  
11.71  
1.00  
3.60  
200 mm THK. FCCP  
100 mm THK. Basecourse  
7.00  
0.60  
1.00  
1.60  
1.00

	<b>NAME OF PROJECT:</b> CONSTRUCTION OF DOWNLAND VEGETABLE/MUSHROOM PRODUCTION BUILDING POB NORTE, LIDUDDA, LIGOGS SUR	<b>SHEET CONTENT:</b> STONE MASONRY DETAILS PCCP DETAILS	<b>PREPARED BY:</b> EZRA JEFF G. SAMPUNO EXECUTIVE CLERK	<b>CHECKED BY:</b> JUDY S. VANTE ARIOLA MUNICIPAL ENGINEER	<b>APPROVED BY:</b> ATTY. SHERWIN P. KIMAS MUNICIPAL MAYOR
--	--	--	--	--	--

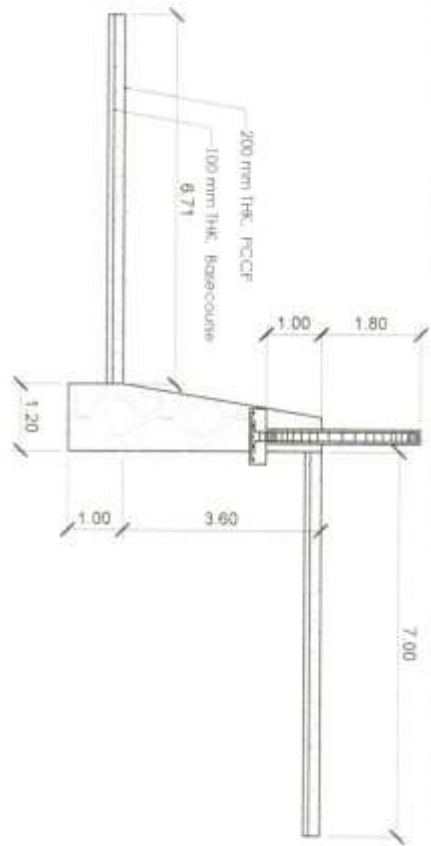

STA. 0+000 - 0+005.25

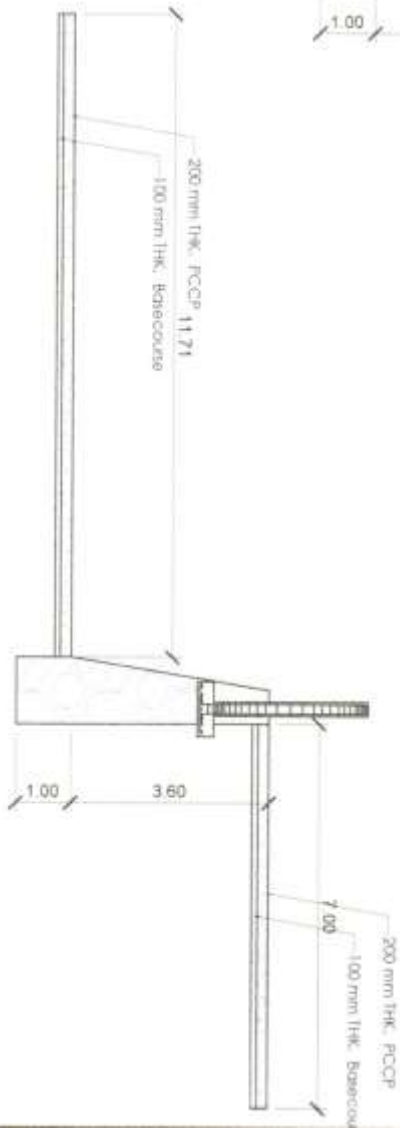

STA. 0+005.25 - 0+007.05

 <p>DEPARTMENT OF AGRICULTURE, FISHERIES AND FORESTRY WESTERN AUSTRALIA</p>	<p>NAME OF PROJECT: CONSTRUCTION OF LOWLAND VEGETABLE/MASSHROOM PRODUCTION BUILDING POB, NORTE LINDIDA, 40005 SUR</p>	<p>SHEET CONTENT: STONE MASONRY DETAILS PCCP DETAILS</p>	<p>PREPARED BY: EZRA JEFFS S. BABAYAT ENGINEER</p>	<p>CHECKED BY: JOEY P. AROLA MUNICIPAL ENGINEER</p>	<p>APPROVED BY: ATTY. SHERWIN P. TOMAS MUNICIPAL ADVOR</p>	<p>SHEET NO: 10 12</p>
--	---	--	--	---	--	--------------------------------

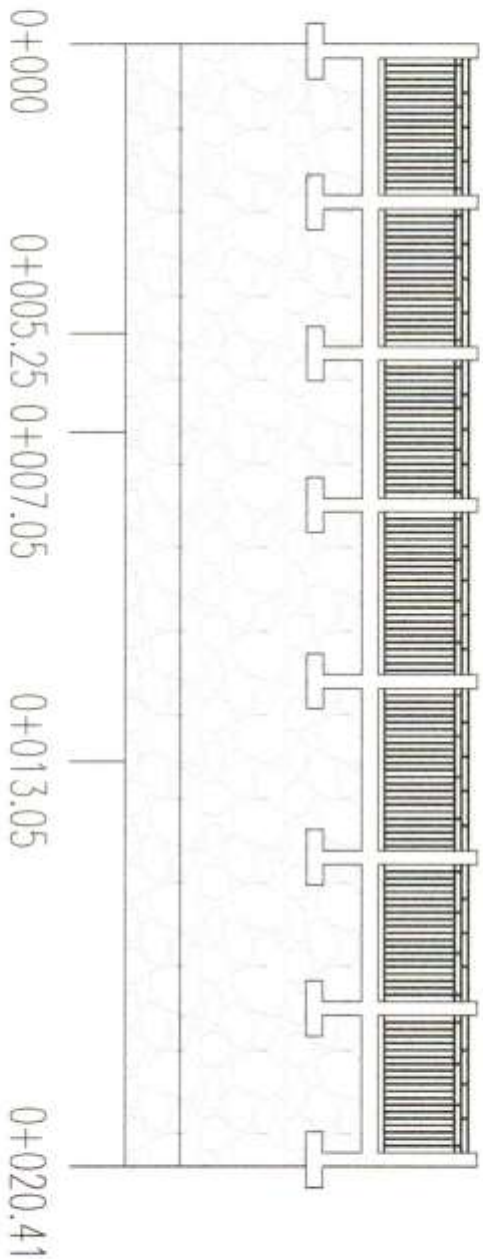

	<b>NAME OF PROJECT</b> CONSTRUCTION OF LOWLAND VEGETABLE/MUSHROOM PRODUCTION BUILDING POB, NORTE, LILUIDA, ILOCOS SUR	<b>SHEET CONTENT</b> STONE MASONRY PROFILE	<b>PREPARED BY:</b>  ENGR. JEFF O. BARDON ENGINEER/ARCHITECT	<b>CHECKED BY:</b>  JULIUS ALBERT E. ARGOLA MUNICIPAL ENGINEER	<b>APPROVED BY:</b>  ATTY. SHERWIN P. TOMAS MUNICIPAL MAYOR	<b>SHEET NO.</b> 
---	---	---	---	--	---	---



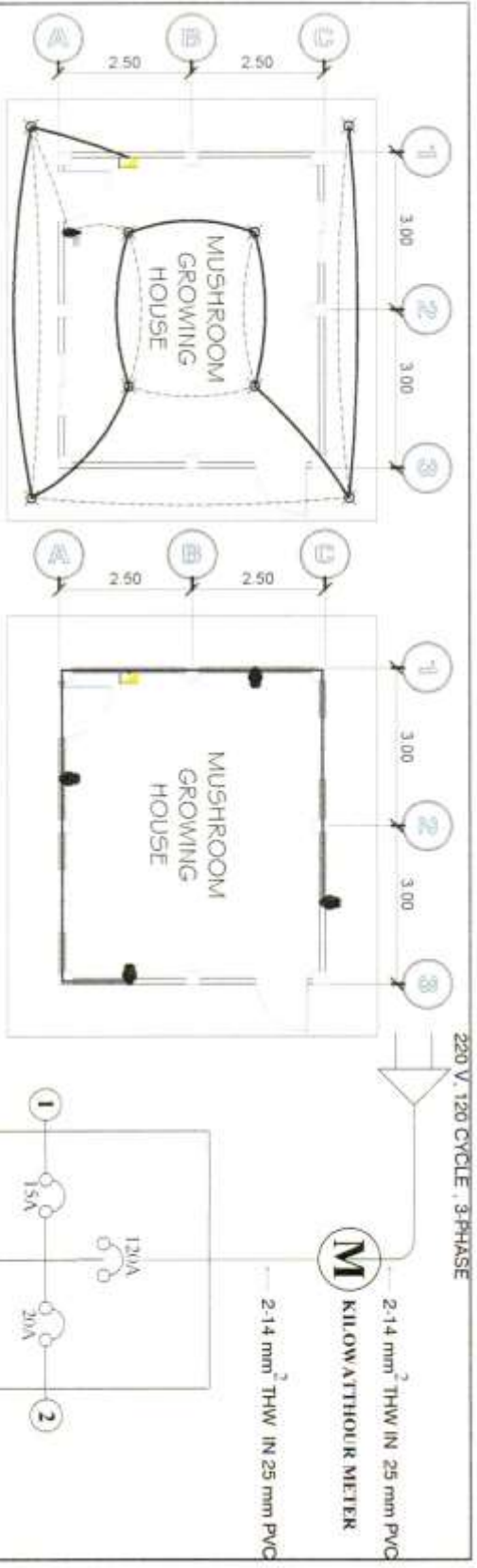

**LIGHTING LAY-OUT**

CIRCUIT NO.	LOAD DESCRIPTION	NO. OF OUTLET	REQUIRED WATTS	TOTAL WATTS	VOL. TB	AMPERE	SIZE OF WIRE	BREAKER(SIZE)	CONDUIT (SIZE)
1	MAIN								1/2" PVC FPE
1	LIGHTING OUTLET	4	100	400	100	1.82	NO. 14 THHN	15A	1/2" PVC FPE
2	CONDUIT OUTLET	4	180	600	180	2.73	NO. 14 THHN	20A	1/2" PVC FPE
3	ACU	1	1400	1400	200	5.78	NO. 12 THHN	20A	1/2" PVC FPE
4	SPARE				100	20.00	NO. 12 THHN	20A	1/2" PVC FPE
5	SPARE				100	20.00	NO. 12 THHN	20A	1/2" PVC FPE
<b>TOTAL</b>					100	20.00	NO. 12 THHN	20A	1/2" PVC FPE

**POWER LAY-OUT**

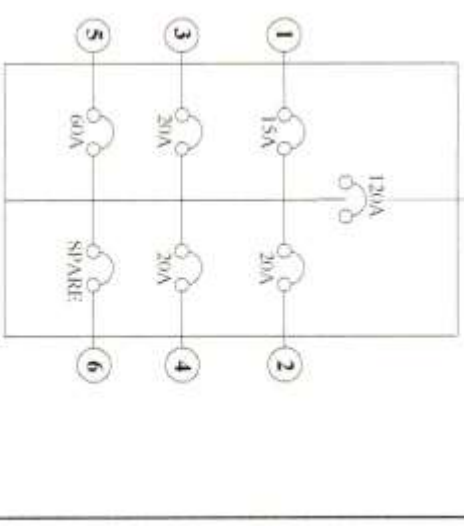

**RIDER DIAGRAM**

DEMAND FACTOR (BPM) = 0.80  
 TOTAL LOADS = 100 AMPERES

MAIN PROTECTION:  
 USE: 100 A, 200 V, 20 DIA. MCB

NAME OF PROJECT: SHEET CONTENT: PREPARED BY: CHECKED BY: APPROVED BY: SHEET NO:

CONSTRUCTION OF LOWLAND VEGETABLE/MUSHROOM PRODUCTION BUILDING  
 RIDER DIAGRAM  
 LOADS COMPUTATION

ESRA JEFF G. TABALAN  
 ELECTRICAL ENGINEER

JULIUS MARTIN E. AROLA  
 MUNICIPAL ENGINEER

ATTY. SHERWIN P. TOMAS  
 MUNICIPAL MAYOR

8  
12

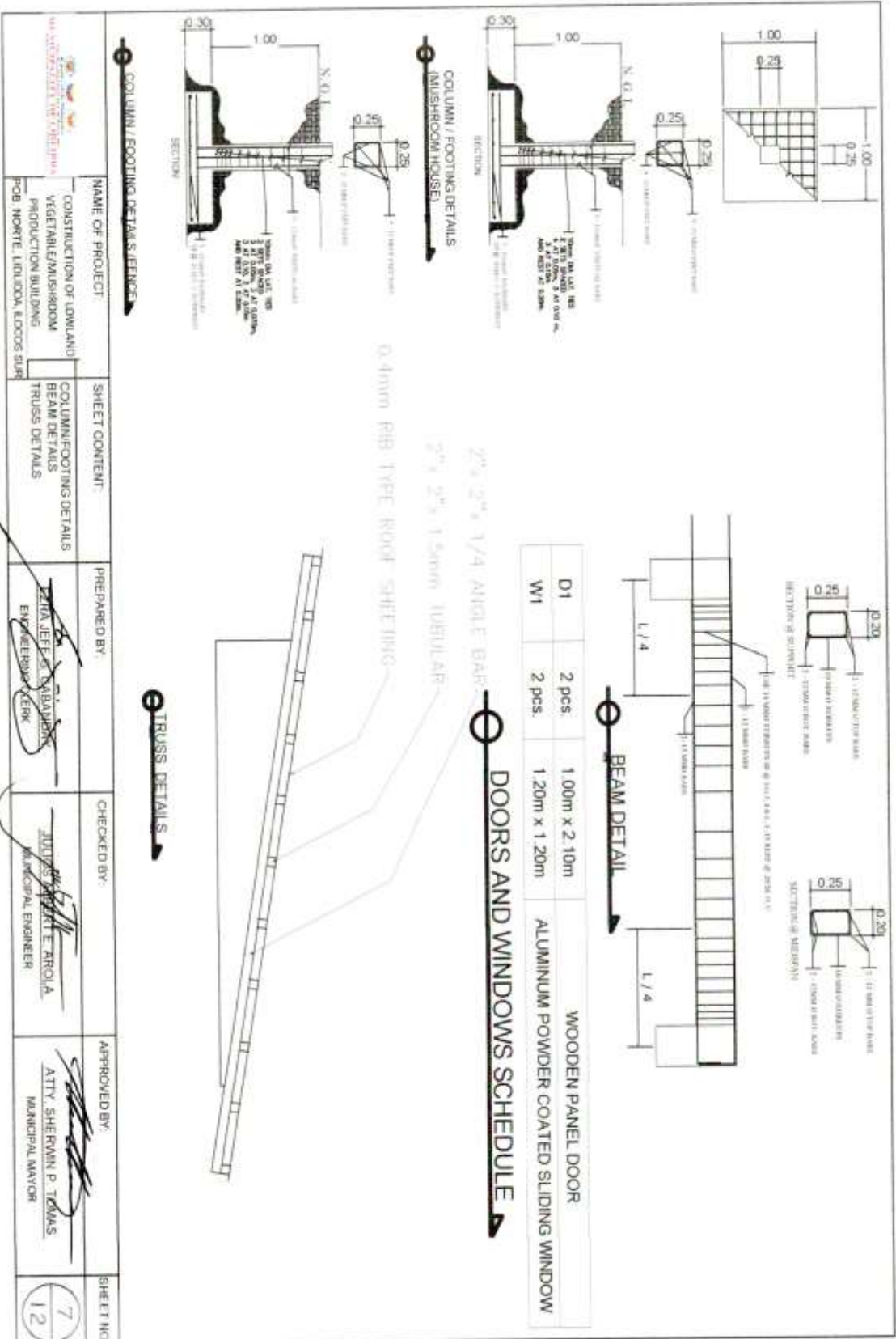

DEPARTMENT OF AGRICULTURE  
 DIVISION OFFICE - MARIKINA CITY  
 NAME OF PROJECT: CONSTRUCTION OF LOWLAND VEGETABLE/MUSHROOM PRODUCTION BUILDING  
 JOB NO: NORTL, LINDRDA, EDOOS SUB

SHEET CONTENT:  
 COLUMN/FOOTING DETAILS  
 BEAM DETAILS  
 TRUSS DETAILS

PREPARED BY:  
  
 ZENA JEFFERSON  
 ENGINEERING FIRM

CHECKED BY:  
  
 JAMES ROBERT E. AROLA  
 MUNICIPAL ENGINEER

APPROVED BY:  
  
 ATTY. SHERWIN P. TOMAS  
 MUNICIPAL MAJOR



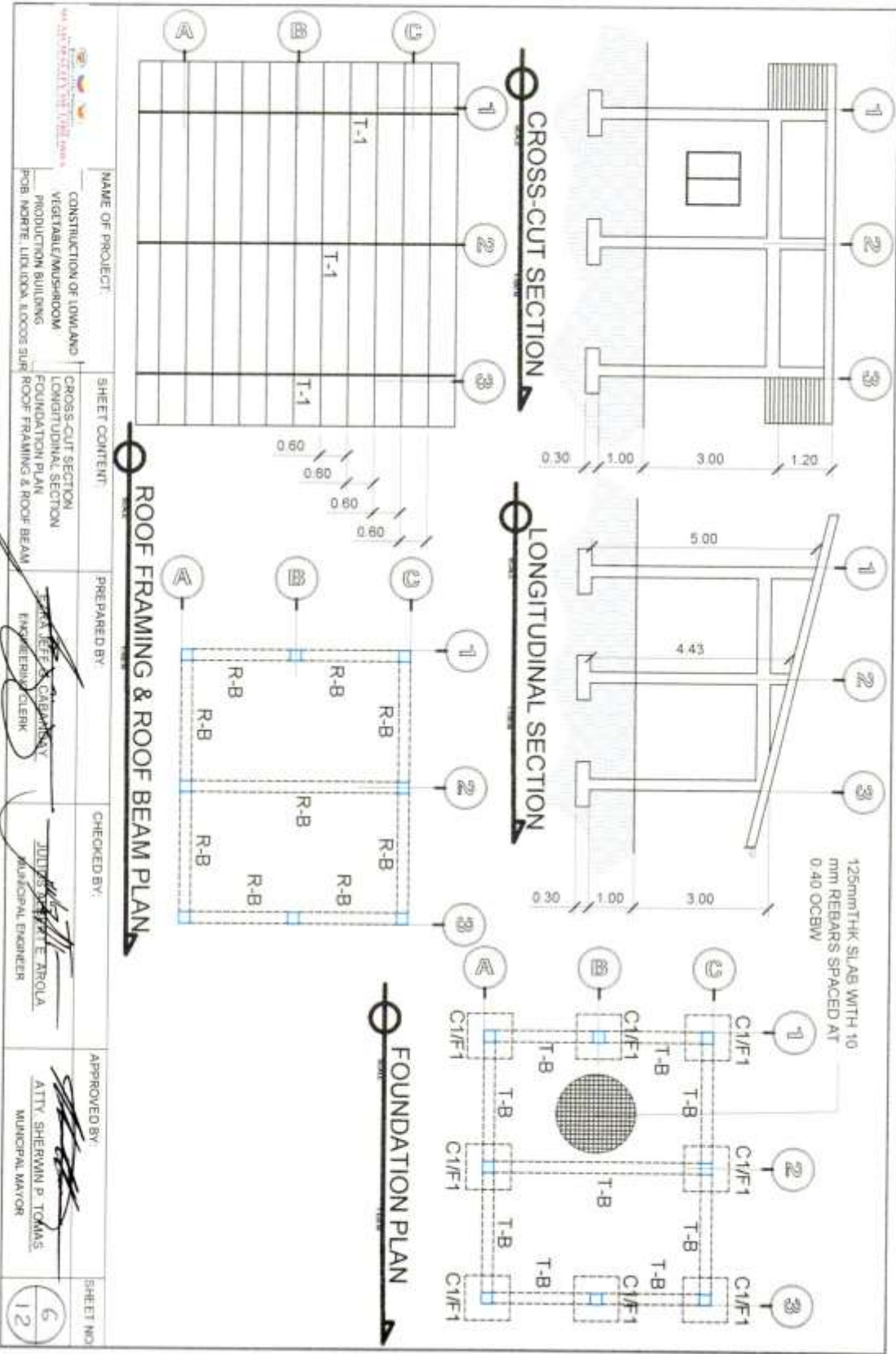

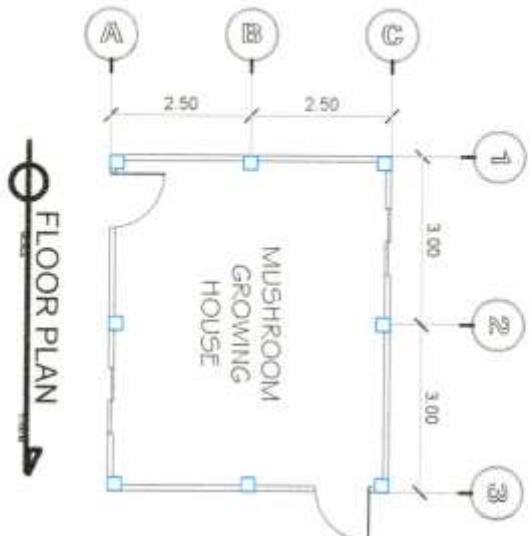
SHEET NO.



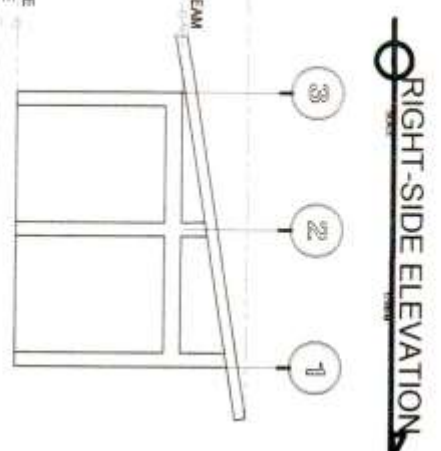
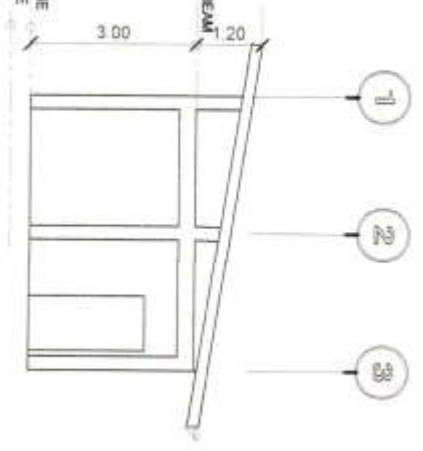
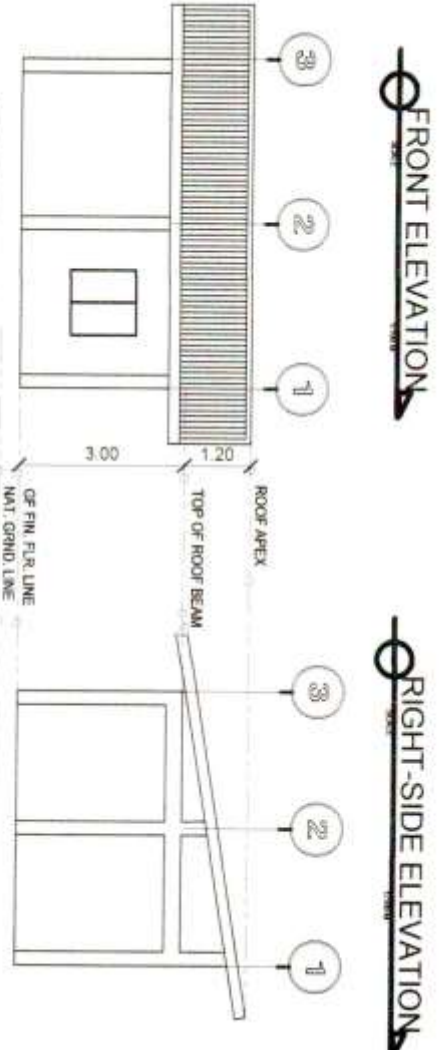
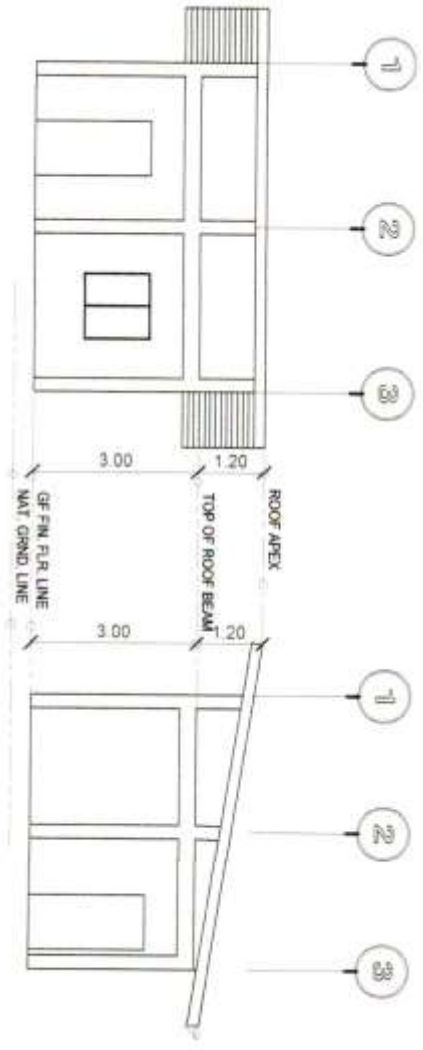

FLOOR PLAN



 NATIONAL CENTER FOR THE HOMELESS CONSTRUCTION OF LOWLAND VEGETABLE/MUSHROOM PRODUCTION BUILDING POB NORTE, LIDJODIA, L0006 SUR	NAME OF PROJECT: CONSTRUCTION OF LOWLAND VEGETABLE/MUSHROOM PRODUCTION BUILDING SHEET CONTENT: FLOOR PLAN, FRONT ELEVATION, RIGHT & LEFT SIDE ELEVATION, REAR ELEVATION	PREPARED BY:  ENGINEERING CLERK	CHECKED BY:  MUNICIPAL ENGINEER	APPROVED BY:  MUNICIPAL MAYOR	SHEET NO. 5 / 12
---	--	--	---	---	---------------------

# PROJECT SITE PROFILE (STATIONING CANAL)

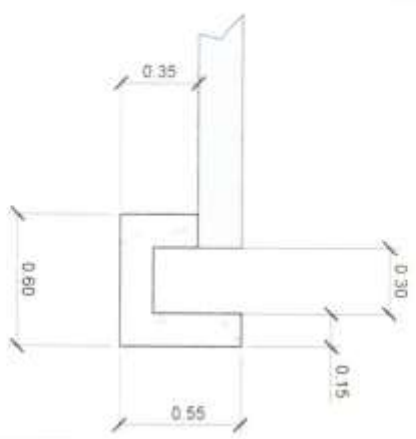

	<b>NAME OF PROJECT</b> CONSTRUCTION OF LOWLAND VEGETABLE/MUSHROOM PRODUCTION BUILDING POB, NORTE LEDIANA, 11000S SUR	<b>SHEET CONTENT</b> SITE PROFILE (CANAL)	<b>PREPARED BY:</b> EZRA JER D. CABALDIA ENGINEERING CLERK	<b>CHECKED BY:</b> JULIE ANNE E. AROLA MUNICIPAL ENGINEER	<b>APPROVED BY:</b> ATTY. SHERWIN P. TOMAS MUNICIPAL MAJOR	<b>SHEET NO.</b> 4 12
--	---	--	--	---	--	-----------------------------

# PROJECT SITE PROFILE

(STATIONING STONE MASONRY AND PCCP)

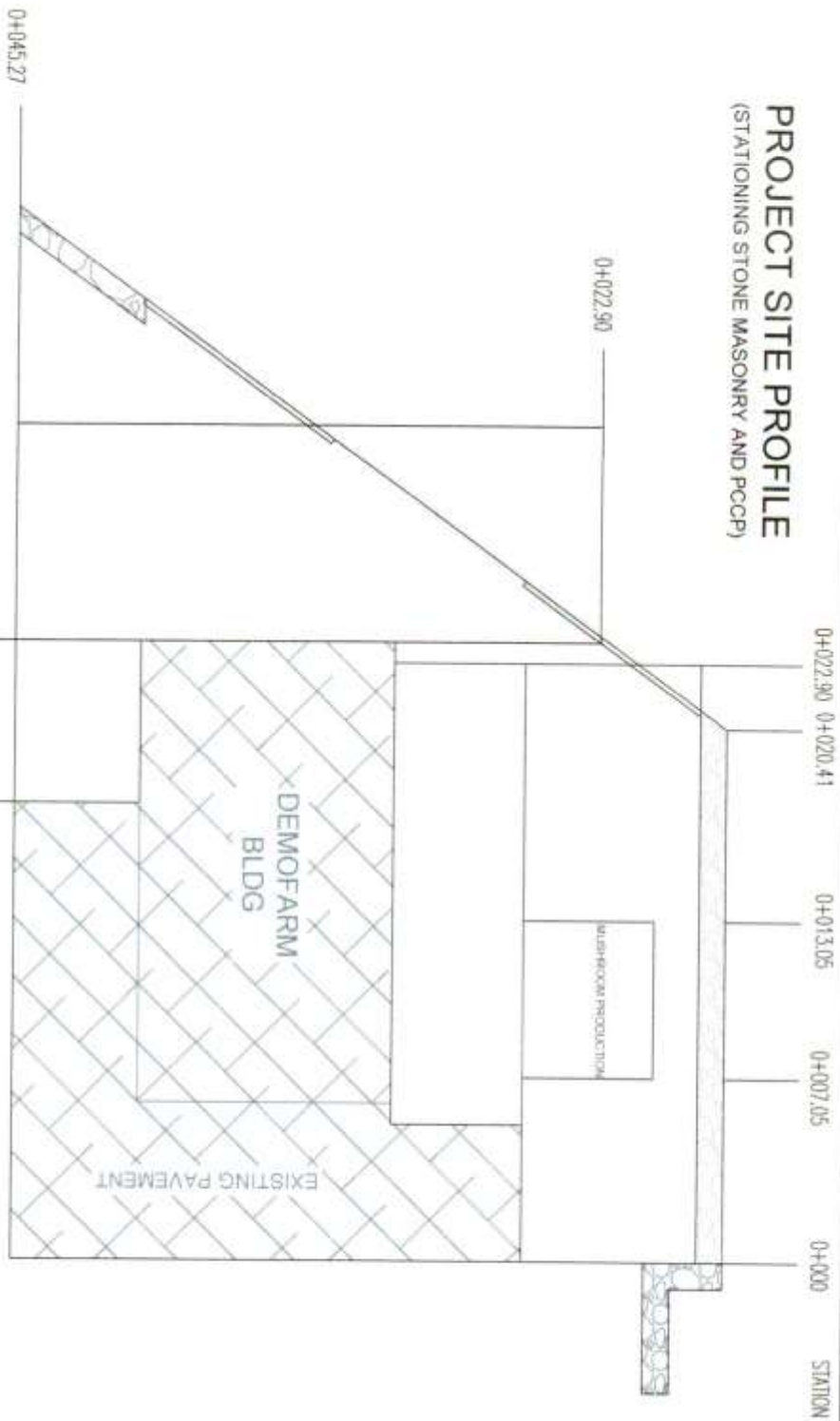

 CITY OF TAMASSEE 1000 S. STATE ST. TAMASSEE, ALA 36080	NAME OF PROJECT CONSTRUCTION OF LOWLAND VEGETABLE/MUSHROOM PRODUCTION BUILDING POB, MORTE, LIDUIDA, ILOOOS SUR	SHEET CONTENT: PROJECT SITE PROFILE (STONE MASONRY & PCCP)	PREPARED BY: EZRA JEFF D. CARABINIX ENGINEER CLERK	CHECKED BY: JULIUS W. WHITE-ABOJA MUNICIPAL ENGINEER	APPROVED BY: ATTY. SHERWIN P. TAMAS MUNICIPAL MAYOR	SHEET NO. 2 / 12
--	--	---	---	--	---	---------------------

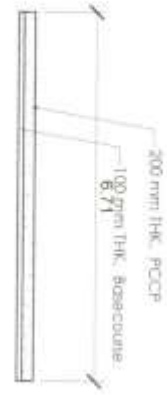

STA. 0+020.41- 0+022.90

STA. 0+022.90- 0+045.27

STA. 0+045.27- 0+051.47

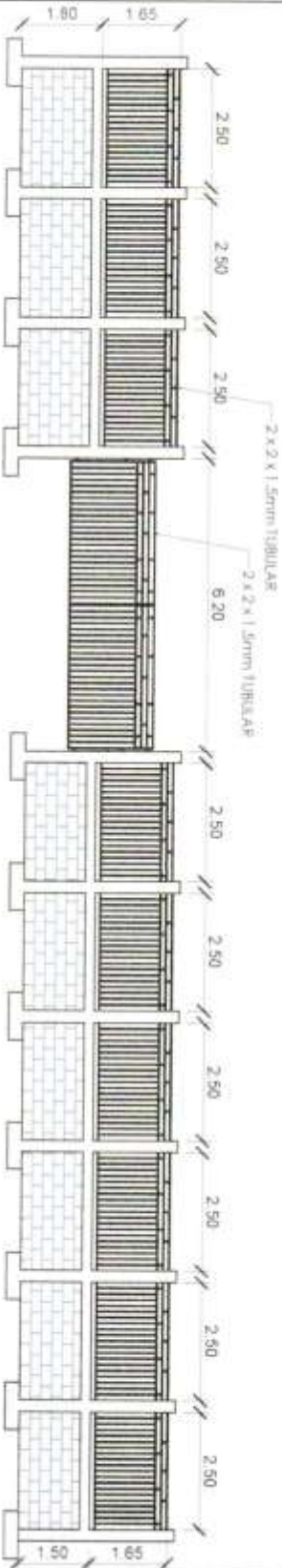

	<p>NAME OF PROJECT: CONSTRUCTION OF LOWLAND VEGETABLE/MUSHROOM PRODUCTION BUILDING POB NORTE, LIDUBDA, 80005 SUR</p>	<p>SHEET CONTENT: POCP DETAILS FENCEGATE DETAILS</p>	<p>PREPARED BY: ZINA JEFF G. CABANATAN ENGINEERING FELLOW</p>	<p>CHECKED BY: JUDAS MARK E. AROLA MUNICIPAL ENGINEER</p>	<p>APPROVED BY: ATTY. SHERWIN P. TOMAS MUNICIPAL MAYOR</p>	<p>SHEET NO. 12 12</p>
--	--	--	---	---	--	--------------------------------

# Section VIII. Bill of Materials

## CONSTRUCTION OF LOWLAND VEGETABLE/ MUSHROOM PRODUCTION BUILDING

POB. NORTE, LIDLIDDA, ILOCOS SUR

DETAILED BREAKDOWNS OF COMPONENT FOR EACH ITEM

ITEM NO.	DESCRIPTION	%	QTY	UNIT	DIRECT COST			TOTAL MAKE UP			TOTAL COST	
					MATERIAL	LABOR	EQUIPMENT	%	VALUE	% EST		
<b>PART B. OTHER GENERAL REQUIREMENTS</b>												
8.5	Project Billboard / Signboard	0.12%	1.00	sqm	3,879.05	0.00	0.00	3,879.05	23%	894.80	282.40	5,801.52
8.7	Occupational Safety and Health Program	0.20%	1.00	hrs	1,873.31	8,324.81	0.00	10,200.14	10%	1,020.01	577.89	12,135.74
<b>TOTAL OF PART B</b>					5,852.36	8,324.81	0.00	14,200.20	3,000.53	830.25	17,235.36	
<b>PART C. REINFORCED CONCRETE WORKS</b>												
404	Reinforcing Steel Bar, Grade 40 (Floor Structure)	5.83%	2,385.25	sqm	347,114.81	13,889.44	13,912.89	375,118.55	15%	43,269.44	10,457.41	223,895.40
405	Structural Concrete Class 4 (Floor Structure)	7.73%	30.22	cu/m	168,424.35	37,151.26	20,488.19	226,063.80	15%	33,909.57	14,144.81	287,124.18
<b>TOTAL OF PART C</b>					515,539.16	51,040.70	34,401.08	601,020.94	3,000.53	84,200.00	24,602.22	530,220.72
<b>PART D. SUBBASE AND BASE COURSE</b>												
200	Aggregate Sub-base Course	1.22%	43.78	cu/m	28,347.10	29.74	5,908.22	34,345.06	15%	5,151.76	2,221.25	46,497.07
<b>TOTAL OF PART D</b>					28,347.10	29.74	5,908.22	34,345.06	1,000.11	2,221.25	46,497.07	
<b>PART E. SURFACE COURSE</b>												
1011a.2	Portland Cement Concrete Pavement (Unfinished), 200mm Thick	22.98%	191.37	sqm	344,219.41	6,333.96	99,312.48	549,865.85	25%	136,966.47	45,305.52	894,311.85
<b>TOTAL OF PART E</b>					344,219.41	6,333.96	99,312.48	549,865.85	1,000.11	45,305.52	894,311.85	
<b>PART F. DRAINAGE AND SLOPE PROTECTION</b>												
500	Stone Heavy	14.28%	128.24	cu/m	174,204.40	46,922.82	37,084.29	258,211.51	25%	64,552.88	25,445.39	322,411.47
<b>TOTAL OF PART F</b>					174,204.40	46,922.82	37,084.29	258,211.51	1,000.11	25,445.39	322,411.47	
<b>PART G. FINISHING</b>												
1003.1	4.5mm/5mm Cement Board on Metal Frame Ceiling	0.38%	30.95	sqm	20,338.31	1,124.42	751.44	22,214.17	25%	5,553.54	1,706.65	27,332.57
1003.1A	Repaired metal frame (ceiling)	1.28%	20.00	sqm	24,300.40	6,121.34	152.11	30,573.85	25%	7,643.47	1,872.24	41,439.56
1000	Aluminum Glass Window (including framing)	0.62%	2.88	sqm	15,425.28	5,402.69	205.28	21,033.25	25%	5,258.31	1,011.74	23,136.89
1010.2B	Wooden Panel Door	0.47%	2.00	sq	14,300.00	4,888.31	498.80	19,686.11	25%	4,921.53	1,217.95	23,136.89
1013.2B	Aluminum Floor Roofing Accessories (Footing/Gutter)	0.34%	30.45	sq	11,888.43	754.99	75.10	12,718.52	25%	3,179.63	817.80	15,275.75
1014	Repaired Metal Sheet (No. Type)	1.27%	30.45	sqm	29,193.60	6,303.21	638.52	36,135.33	25%	9,033.83	2,258.46	44,493.74
1021.1	Cement Plaster Finish	1.48%	249.42	sqm	28,323.36	17,933.75	1,763.33	48,020.44	25%	12,005.11	3,643.79	64,369.57
1021.1A	Plastering Works (Plastering)	1.19%	244.42	sqm	31,279.50	36,940.89	3,948.16	72,168.55	25%	18,042.14	4,421.22	87,236.68
1040	3.0mm Oil-Tan Lead Sheeting (Including Reinforcing)	1.54%	94.42	sqm	17,424.24	11,180.07	5,363.82	33,968.13	25%	8,492.03	4,421.22	47,881.38
1047.1A	Structural Steel Trusses	0.44%	104.87	kg	12,358.37	1,311.88	781.88	14,452.13	25%	3,613.03	901.00	18,936.94
1100.10	Conduit Works, Buses and fittings	0.42%	1.00	sq	3,360.00	4,885.26	405.51	8,650.77	25%	2,162.69	541.13	14,254.57
1101.10	Wire and fitting (cable)	1.79%	1.00	sq	43,425.00	6,610.34	801.36	50,836.70	25%	12,709.18	3,244.79	64,390.67
1102	Panel Board	0.42%	1.00	sq	16,400.00	1,247.88	124.75	17,772.63	25%	4,443.16	1,111.91	19,467.50
1103	Lighting Fixture	0.44%	1.00	sq	6,000.00	4,888.31	498.80	11,387.11	25%	2,846.78	711.93	12,705.82
1021.1A	Plastering Works (Plastering)	2.30%	128.42	sqm	27,802.32	37,245.79	3,738.57	68,786.68	25%	17,196.67	4,274.16	82,263.51
1101.11	Roofing	0.88%	1,170.33	sqm	191,327.31	31,477.47	44,808.61	267,613.39	25%	66,903.35	16,725.89	349,742.63
1200	Acoustical Ceiling System	1.82%	1.00	sq	52,878.94	6.00	0.00	52,884.94	25%	13,221.24	3,304.81	64,411.19
201.4	Transformer	17.15%	1.00	sq	800,000.00	0.00	0.00	800,000.00	25%	200,000.00	50,000.00	1,050,000.00
201.2	Shelving Cabinet	0.45%	1.00	sq	20,000.00	0.00	0.00	20,000.00	25%	5,000.00	1,250.00	26,250.00
<b>TOTAL OF PART G</b>					1,060,037.12	201,063.74	61,057.96	1,322,158.82	3,000.53	84,421.01	1,772,883.57	
<b>GRAND TOTAL</b>					2,220,763.41	233,274.41	146,164.01	2,600,191.83	100.00%	100,121.43	3,824,549.05	





# Section IX. Checklist of Technical and Financial Documents

## Checklist of Technical and Financial Documents

### I. TECHNICAL COMPONENT ENVELOPE

#### *Class “A” Documents*

##### Legal Documents

- (a) Valid PhilGEPS Registration Certificate (Platinum Membership) (all pages);  
**or**
- (b) Registration certificate from Securities and Exchange Commission (SEC), Department of Trade and Industry (DTI) for sole proprietorship, or Cooperative Development Authority (CDA) for cooperatives or its equivalent document;  
**and**
- (c) Mayor’s or Business permit issued by the city or municipality where the principal place of business of the prospective bidder is located, or the equivalent document for Exclusive Economic Zones or Areas;  
**and**
- (e) Tax clearance per E.O. No. 398, s. 2005, as finally reviewed and approved by the Bureau of Internal Revenue (BIR).

##### Technical Documents

- (f) Statement of the prospective bidder of all its ongoing government and private contracts, including contracts awarded but not yet started, if any, whether similar or not similar in nature and complexity to the contract to be bid; **and**
- (g) Statement of the bidder’s Single Largest Completed Contract (SLCC) similar to the contract to be bid, except under conditions provided under the rules;  
**and**
- (h) Philippine Contractors Accreditation Board (PCAB) License;  
**or**  
Special PCAB License in case of Joint Ventures;  
**and** registration for the type and cost of the contract to be bid; **and**
- (i) Original copy of Bid Security. If in the form of a Surety Bond, submit also a certification issued by the Insurance Commission;  
**or**  
Original copy of Notarized Bid Securing Declaration; **and**
- (j) Project Requirements, which shall include the following:
  - a. Organizational chart for the contract to be bid;
  - b. List of contractor’s key personnel (*e.g.*, Project Manager, Project Engineers, Materials Engineers, and Foremen), to be assigned to the contract to be bid, with their complete qualification and experience data;
  - c. List of contractor’s major equipment units, which are owned, leased, and/or under purchase agreements, supported by proof of ownership or certification of availability of equipment from the equipment lessor/vendor for the duration of the project, as the case may be; **and**
- (k) Original duly signed Omnibus Sworn Statement (OSS);  
**and** if applicable, Original Notarized Secretary’s Certificate in case of a corporation, partnership, or cooperative; or Original Special Power of

Attorney of all members of the joint venture giving full power and authority to its officer to sign the OSS and do acts to represent the Bidder.

Financial Documents

- (l) The prospective bidder's audited financial statements, showing, among others, the prospective bidder's total and current assets and liabilities, stamped "received" by the BIR or its duly accredited and authorized institutions, for the preceding calendar year which should not be earlier than two (2) years from the date of bid submission; **and**
- (m) The prospective bidder's computation of Net Financial Contracting Capacity (NFCC).

***Class "B" Documents***

- (n) If applicable, duly signed joint venture agreement (JVA) in accordance with RA No. 4566 and its IRR in case the joint venture is already in existence;  
**or**  
duly notarized statements from all the potential joint venture partners stating that they will enter into and abide by the provisions of the JVA in the instance that the bid is successful.

**II. FINANCIAL COMPONENT ENVELOPE**

- (o) Original of duly signed and accomplished Financial Bid Form; **and**

Other documentary requirements under RA No. 9184

- (p) Original of duly signed Bid Prices in the Bill of Quantities; **and**
- (q) Duly accomplished Detailed Estimates Form, including a summary sheet indicating the unit prices of construction materials, labor rates, and equipment rentals used in coming up with the Bid; **and**
- (r) Cash Flow by Quarter.



# BID FORMS

## NOTES FOR THE BIDDER:

*“Italicized words are not part of the final documents. It was only included as your guide in filling up the following Bid Forms.”*

**“OTHER BIDDING DOCUMENT FORMS CAN BE DOWNLOADED AT THE GPPB WEBSITE - DOWNLOADABLE FORMS”**

Bid Form for the Procurement of Infrastructure Projects

[shall be submitted with the Bid]

**BID FORM**

Date : \_\_\_\_\_

Project Identification No. : \_\_\_\_\_

To: [name and address of Procuring Entity]

Having examined the Philippine Bidding Documents (PBDs) including the Supplemental or Bid Bulletin Numbers [insert numbers], the receipt of which is hereby duly acknowledged, we, the undersigned, declare that:

- a. We have no reservation to the PBDs, including the Supplemental or Bid Bulletins, for the Procurement Project: [insert name of contract];
- b. We offer to execute the Works for this Contract in accordance with the PBDs;
- c. The total price of our Bid in words and figures, excluding any discounts offered below is: [insert information];
- d. The discounts offered and the methodology for their application are: [insert information];
- e. The total bid price includes the cost of all taxes, such as, but not limited to: [specify the applicable taxes, e.g. (i) value added tax (VAT), (ii) income tax, (iii) local taxes, and (iv) other fiscal levies and duties], which are itemized herein and reflected in the detailed estimates,
- f. Our Bid shall be valid within the a period stated in the PBDs, and it shall remain binding upon us at any time before the expiration of that period;
- g. If our Bid is accepted, we commit to obtain a Performance Security in the amount of [insert percentage amount] percent of the Contract Price for the due performance of the Contract, or a Performance Securing Declaration in lieu of the the allowable forms of Performance Security, subject to the terms and conditions of issued GPPB guidelines<sup>12</sup> for this purpose;
- h. We are not participating, as Bidders, in more than one Bid in this bidding process, other than alternative offers in accordance with the Bidding Documents;
- i. We understand that this Bid, together with your written acceptance thereof included in your notification of award, shall constitute a binding contract between us, until a formal Contract is prepared and executed; and
- j. We understand that you are not bound to accept the Lowest Calculated Bid or any other Bid that you may receive.
- k. We likewise certify/confirm that the undersigned, is the duly authorized representative of the bidder, and granted full power and authority to do, execute and perform any and all acts necessary to participate, submit the bid, and to sign and execute the ensuing contract for the [Name of Project] of the [Name of the Procuring Entity].
- l. We acknowledge that failure to sign each and every page of this Bid Form, including the Bill of Quantities, shall be a ground for the rejection of our bid.

Name: \_\_\_\_\_

Legal Capacity: \_\_\_\_\_

Signature: \_\_\_\_\_

Duly authorized to sign the Bid for and behalf of: \_\_\_\_\_

Date: \_\_\_\_\_

## Bid Securing Declaration Form

*[shall be submitted with the Bid if bidder opts to provide this form of bid security]*

REPUBLIC OF THE PHILIPPINES)  
CITY OF \_\_\_\_\_) S.S.

### **BID SECURING DECLARATION** **Project Identification No.: *[Insert number]***

To: *[Insert name and address of the Procuring Entity]*

I/We, the undersigned, declare that:

1. I/We understand that, according to your conditions, bids must be supported by a Bid Security, which may be in the form of a Bid Securing Declaration.
2. I/We accept that: (a) I/we will be automatically disqualified from bidding for any procurement contract with any procuring entity for a period of two (2) years upon receipt of your Blacklisting Order; and, (b) I/we will pay the applicable fine provided under Section 6 of the Guidelines on the Use of Bid Securing Declaration, within fifteen (15) days from receipt of the written demand by the procuring entity for the commission of acts resulting to the enforcement of the bid securing declaration under Sections 23.1(b), 34.2, 40.1 and 69.1, except 69.1(f), of the IRR of RA No. 9184; without prejudice to other legal action the government may undertake.
3. I/We understand that this Bid Securing Declaration shall cease to be valid on the following circumstances:
  - a. Upon expiration of the bid validity period, or any extension thereof pursuant to your request;
  - b. I am/we are declared ineligible or post-disqualified upon receipt of your notice to such effect, and (i) I/we failed to timely file a request for reconsideration or (ii) I/we filed a waiver to avail of said right; and
  - c. I am/we are declared the bidder with the Lowest Calculated Responsive Bid, and I/we have furnished the performance security and signed the Contract.

IN WITNESS WHEREOF, I/We have hereunto set my/our hand/s this \_\_\_\_ day of *[month]* *[year]* at *[place of execution]*.

*[Insert NAME OF BIDDER OR ITS AUTHORIZED REPRESENTATIVE]*

*[Insert signatory's legal capacity]*

Affiant

**[Jurat]**

*[Format shall be based on the latest Rules on Notarial Practice]*

## Omnibus Sworn Statement (Revised)

*[shall be submitted with the Bid]*

REPUBLIC OF THE PHILIPPINES )  
CITY/MUNICIPALITY OF \_\_\_\_\_ ) S.S.

### AFFIDAVIT

I, [Name of Affiant], of legal age, [Civil Status], [Nationality], and residing at [Address of Affiant], after having been duly sworn in accordance with law, do hereby depose and state that:

1. *[Select one, delete the other:]*

*[If a sole proprietorship:]* I am the sole proprietor or authorized representative of [Name of Bidder] with office address at [address of Bidder];

*[If a partnership, corporation, cooperative, or joint venture:]* I am the duly authorized and designated representative of [Name of Bidder] with office address at [address of Bidder];

2. *[Select one, delete the other:]*

*[If a sole proprietorship:]* As the owner and sole proprietor, or authorized representative of [Name of Bidder], I have full power and authority to do, execute and perform any and all acts necessary to participate, submit the bid, and to sign and execute the ensuing contract for [Name of the Project] of the [Name of the Procuring Entity], as shown in the attached duly notarized Special Power of Attorney;

*[If a partnership, corporation, cooperative, or joint venture:]* I am granted full power and authority to do, execute and perform any and all acts necessary to participate, submit the bid, and to sign and execute the ensuing contract for [Name of the Project] of the [Name of the Procuring Entity], as shown in the attached [state title of attached document showing proof of authorization (e.g., duly notarized Secretary's Certificate, Board/Partnership Resolution, or Special Power of Attorney, whichever is applicable)];

3. *[Name of Bidder]* is not "blacklisted" or barred from bidding by the Government of the Philippines or any of its agencies, offices, corporations, or Local Government Units, foreign government/foreign or international financing institution whose blacklisting rules have been recognized by the Government Procurement Policy Board, **by itself or by relation, membership, association, affiliation, or controlling interest with another blacklisted person or entity as defined and provided for in the Uniform Guidelines on Blacklisting;**

4. Each of the documents submitted in satisfaction of the bidding requirements is an authentic copy of the original, complete, and all statements and information provided therein are true and correct;

5. *[Name of Bidder]* is authorizing the Head of the Procuring Entity or its duly authorized representative(s) to verify all the documents submitted;

6. *[Select one, delete the rest:]*

*[If a sole proprietorship:]* The owner or sole proprietor is not related to the Head of the Procuring Entity, members of the Bids and Awards Committee (BAC), the Technical Working Group, and the BAC Secretariat, the head of the Project Management Office or the end-user unit, and the project consultants by consanguinity or affinity up to the third civil degree;

*[If a partnership or cooperative:]* None of the officers and members of *[Name of Bidder]* is related to the Head of the Procuring Entity, members of the Bids and Awards Committee (BAC), the Technical Working Group, and the BAC Secretariat, the head of the Project Management Office or the end-user unit, and the project consultants by consanguinity or affinity up to the third civil degree;

[If a corporation or joint venture:] None of the officers, directors, and controlling stockholders of [Name of Bidder] is related to the Head of the Procuring Entity, members of the Bids and Awards Committee (BAC), the Technical Working Group, and the BAC Secretariat, the head of the Project Management Office or the end-user unit, and the project consultants by consanguinity or affinity up to the third civil degree;

7. [Name of Bidder] complies with existing labor laws and standards; and
8. [Name of Bidder] is aware of and has undertaken the responsibilities as a Bidder in compliance with the Philippine Bidding Documents, which includes:
  - a. Carefully examining all of the Bidding Documents;
  - b. Acknowledging all conditions, local or otherwise, affecting the implementation of the Contract;
  - c. Making an estimate of the facilities available and needed for the contract to be bid, if any; and
  - d. Inquiring or securing Supplemental/Bid Bulletin(s) issued for the [Name of the Project].
9. [Name of Bidder] did not give or pay directly or indirectly, any commission, amount, fee, or any form of consideration, pecuniary or otherwise, to any person or official, personnel or representative of the government in relation to any procurement project or activity.
10. **In case advance payment was made or given, failure to perform or deliver any of the obligations and undertakings in the contract shall be sufficient grounds to constitute criminal liability for Swindling (Estafa) or the commission of fraud with unfaithfulness or abuse of confidence through misappropriating or converting any payment received by a person or entity under an obligation involving the duty to deliver certain goods or services, to the prejudice of the public and the government of the Philippines pursuant to Article 315 of Act No. 3815 s. 1930, as amended, or the Revised Penal Code.**

IN WITNESS WHEREOF, I have hereunto set my hand this \_\_ day of \_\_, 20\_\_ at \_\_\_\_\_, Philippines.

*[Insert NAME OF BIDDER OR ITS AUTHORIZED REPRESENTATIVE]*

*[Insert signatory's legal capacity]*

Affiant

**[Jurat]**

*[Format shall be based on the latest Rules on Notarial Practice]*

Contract Agreement Form for the Procurement of Infrastructure Projects (Revised)  
*[not required to be submitted with the Bid, but it shall be submitted within ten (10) days after receiving the Notice of Award]*

---

**CONTRACT AGREEMENT**

THIS AGREEMENT, made this *[insert date]* day of *[insert month]*, *[insert year]* between *[name and address of PROCURING ENTITY]* (hereinafter called the “Entity”) and *[name and address of Contractor]* (hereinafter called the “Contractor”).

WHEREAS, the Entity is desirous that the Contractor execute *[name and identification number of contract]* (hereinafter called “the Works”) and the Entity has accepted the Bid for *[contract price in words and figures in specified currency]* by the Contractor for the execution and completion of such Works and the remedying of any defects therein.

NOW THIS AGREEMENT WITNESSETH AS FOLLOWS:

1. In this Agreement, words and expressions shall have the same meanings as are respectively assigned to them in the Conditions of Contract hereinafter referred to.

2. The following documents as required by the 2016 revised Implementing Rules and Regulations of Republic Act No. 9184 shall be deemed to form and be read and construed as part of this Agreement, viz.:

- a. Philippine Bidding Documents (PBDs); i. Drawings/Plans; ii. Specifications; iii. Bill of Quantities; iv. General and Special Conditions of Contract; v. Supplemental or Bid Bulletins, if any;
- b. Winning bidder’s bid, including the Eligibility requirements, Technical and Financial Proposals, and all other documents or statements submitted;

Bid form, including all the documents/statements contained in the Bidder’s bidding envelopes, as annexes, and all other documents submitted (e.g., Bidder’s response to request for clarifications on the bid), including corrections to the bid, if any, resulting from the Procuring Entity’s bid evaluation;

- c. Performance Security;
- d. Notice of Award of Contract and the Bidder’s conforme thereto; and
- e. Other contract documents that may be required by existing laws and/or the Procuring Entity concerned in the PBDs. Winning bidder agrees that additional contract documents or information prescribed by the GPPB that are subsequently required for submission after the contract execution, such as the Notice to Proceed, Variation Orders, and Warranty Security, shall likewise form part of the Contract.

3. In consideration for the sum of *[total contract price in words and figures]* or such other sums as may be ascertained, *[Named of the bidder]* agrees to *[state the object of the contract]* in accordance with his/her/its Bid.

4. The *[Name of the procuring entity]* agrees to pay the above-mentioned sum in accordance with the terms of the Bidding.

IN WITNESS whereof the parties thereto have caused this Agreement to be executed the day and year first before written.

*[Insert Name and Signature]*

*[Insert Name and Signature]*

*[Insert Signatory’s Legal Capacity]*  
for:

*[Insert Signatory’s Legal Capacity]*  
for:

*[Insert Procuring Entity]*

*[Insert Name of Supplier]*

Acknowledgment *[Format shall be based on the latest Rules on Notarial Practice]*



**Performance Securing Declaration (Revised)**

*[if used as an alternative performance security but it is not required to be submitted with the Bid, as it shall be submitted within ten (10) days after receiving the Notice of Award]*

REPUBLIC OF THE PHILIPPINES)  
CITY OF \_\_\_\_\_ ) S.S.

**PERFORMANCE SECURING DECLARATION**

Invitation to Bid: *[Insert Reference Number indicated in the Bidding Documents]*

To: *[Insert name and address of the Procuring Entity]*

I/We, the undersigned, declare that:

1. I/We understand that, according to your conditions, to guarantee the faithful performance by the supplier/distributor/manufacture/contractor/consultant of its obligations under the Contract, I/we shall submit a Performance Securing Declaration within a maximum period of ten (10) calendar days from the receipt of the Notice of Award prior to the signing of the Contract.
2. I/We accept that: I/we will be automatically disqualified from bidding for any procurement contract with any procuring entity for a period of one (1) year for the first offense, or two (2) years **for the second offense**, upon receipt of your Blacklisting Order if I/We have violated my/our obligations under the Contract;
3. I/We understand that this Performance Securing Declaration shall cease to be valid upon:
  - a. issuance by the Procuring Entity of the Certificate of Final Acceptance, subject to the following conditions:
    - i. Procuring Entity has no claims filed against the contract awardee;
    - ii. It has no claims for labor and materials filed against the contractor; and
    - iii. Other terms of the contract; or
  - b. replacement by the winning bidder of the submitted PSD with a performance security in any of the prescribed forms under Section 39.2 of the 2016 revised IRR of RA No. 9184 as required by the end-user.

**IN WITNESS WHEREOF**, I/We have hereunto set my/our hand/s this \_\_\_\_ day of *[month]* *[year]* at *[place of execution]*.

*[Insert NAME OF BIDDER OR ITS AUTHORIZED REPRESENTATIVE]*

*[Insert signatory's legal capacity]*

Affiant

**[Jurat]**

*[Format shall be based on the latest Rules on Notarial Practice]*